

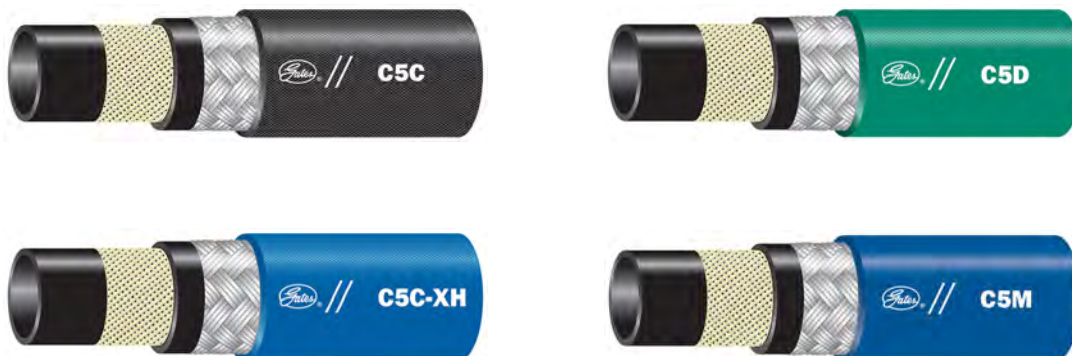

## HYDRAULIC HOSE FOR C5C, C5CXH, C5D & C5M COUPLINGS



## HYDRAULIC HOSE FOR C5E COUPLINGS



**The Gates eCrimp program** is a web based utility which allows users and distributors of Gates hydraulic and industrial hose products to find and print the most up to date crimp specifications with nothing more than an internet browser.

This program can be used to find crimp data for all Gates crimpers. Custom result may be printed by selecting the crimper, hose and coupling. Optionally results may also be limited by die set and working pressure.

The eCrimp web application can be directly accessed from a web browser by entering <http://eCrimp.Gates.com> for the website.

**The eCrimp mobile app** is available for download for the iPhone and iPad from the App Store.

EQUIPMENT
HOSE/CPLG. SELECTION
G8K COUPLINGS
GLOBALSPIRAL COUPLINGS
STAINLESS STEEL SPIRAL
MEGACRIMP COUPLINGS
STAINLESS STEEL BRAID
POWER CRIMP COUPLINGS
FIELD ATTACHABLE G1 & G2 COUPLINGS
FIELD ATTACHABLE C5 COUPLINGS
C14 COUPLINGS
GL COUPLINGS
GLX COUPLINGS
PCTS THERMOPLASTIC COUPLINGS
POLARSEAL COUPLINGS (ACA)
POLARSEAL II COUPLINGS (ACC)
POLARSEAL II COUPLINGS (ACB)
POWER STEERING
ADAPTERS
QUICK DISCONNECT COUPLERS
BALL VALVES
LIVE SWIVEL
ASSEMBLY FABRICATION
ACCESSORIES
EQUIPMENT AND PARTS
KITS
AIR BRAKE HOSE ASSY
BRASS



EQUIPMENT
HOSE/CPLG. SELECTION
G8K COUPLINGS
GLOBAL SPIRAL COUPLINGS
STAINLESS STEEL SPIRAL
MEGACRIMP COUPLINGS
STAINLESS STEEL BRAID
POWER CRIMP COUPLINGS
FIELD ATTACHABLE G1 & G2 COUPLINGS
FIELD ATTACHABLE C5 COUPLINGS
C14 COUPLINGS
GL COUPLINGS
GLX COUPLINGS
PCTS THERMOPLASTIC COUPLINGS
POLARSEAL COUPLINGS (ACA)
POLARSEAL II COUPLINGS (ACC)
POLARSEAL II COUPLINGS (ACB)
POWER STEERING
ADAPTERS
QUICK DISCONNECT COUPLERS
BALL VALVES
LIVE SWIVEL
ASSEMBLY FABRICATION
ACCESSORIES
EQUIPMENT AND PARTS
KITS
AIR BRAKE HOSE ASSY
BRASS

## Male Pipe (NPTF - 30° Cone Seat) - Steel

DOT FMVSS 106-74 Type All.

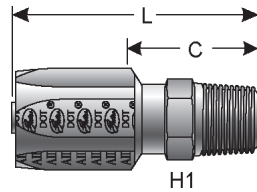

H1

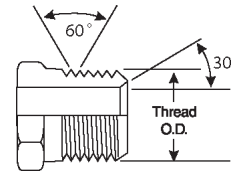

Part No.	Descr.	Prod. No.	⊖		H1	L		C		
			"	mm		"	mm	"	mm	
G34100-0402	4C5-2RMP	7236-04015	3/16	4.8	1/8-27	1/2	1.64	41.7	.94	23.9
G34100-0404	4C5-4RMP	7236-04025	3/16	4.8	1/4-18	9/16	1.83	46.5	1.13	28.7
G34100-0502	5C5X-2RMP	7237-00145	1/4	6.4	1/8-27	1/2	1.77	45.0	1.00	25.4
G34100-0504	5C5X-4RMP	7237-00155	1/4	6.4	1/4-18	9/16	1.96	49.8	1.19	30.2
G34100-0604	6C5-4RMP	7236-04055	5/16	7.9	1/4-18	9/16	2.17	55.1	1.22	31.0
G34100-0606	6C5-6RMP	7236-04275	5/16	7.9	3/8-18	11/16	2.17	55.1	1.22	31.0
G34100-0806	8C5X-6RMP	7237-00195	13/32	10.3	3/8-18	11/16	2.46	62.5	1.34	34.0
G34100-0808	8C5X-8RMP	7237-00205	13/32	10.3	1/2-14	7/8	2.71	68.8	1.59	40.4
G34100-1008	10C5-8RMP	7236-04085	1/2	12.7	1/2-14	1 1/16	2.88	73.2	1.59	40.4
G34100-1012	10C5-12RMP	7236-04095	1/2	12.7	3/4-14	1	2.95	74.9	1.66	42.2
G34100-1208	12C5X-8RMP	7237-00235	5/8	15.9	1/2-14	7/8	3.15	80.0	1.59	40.4
G34100-1212	12C5X-12RMP	7237-00245	5/8	15.9	3/4-14	1 1/16	3.25	82.6	1.69	42.9
G34100-1612	16C5-12RMP	7236-86412	7/8	22.2	3/4-14	1 1/8	2.71	68.8	1.53	38.9
G34100-1616	16C5-16RMP	7236-86413	7/8	22.2	1-11 1/2	1 3/8	2.90	73.7	1.72	43.7
G34100-2020	20C5-20RMP	7236-86428	1 1/8	28.6	1 1/4-11 1/2	1 11/16	3.25	82.6	1.88	47.8
G34100-2424	24C5-24RMP	7236-86388	1 3/8	34.9	1 1/2-11 1/2	2	3.45	87.6	2.03	51.6
G34100-3232	32C5-32RMP	7236-86389	1 13/16	46.0	2-11 1/2	2 1/2	4.07	103.4	2.22	56.4

## Male Pipe (NPTF - 30° Cone Seat) - Brass

DOT FMVSS 106-74 Type All.

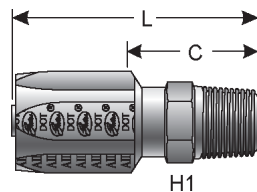

H1

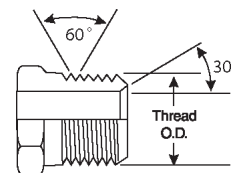

Part No.	Descr.	Prod. No.	⊖		H1	L		C		
			"	mm		"	mm	"	mm	
△ G34100-0606B	6C5-6RMPB	7236-03015	5/16	7.9	3/8-18	11/16	2.17	55.1	1.22	31.0
△ G34100-0808B	8C5-8RMPB	7236-03085	13/32	10.3	1/2-14	7/8	2.71	68.8	1.59	40.4
△ G34100-1008B	10C5-8RMPB	7236-03035	1/2	12.7	1/2-14	7/8	2.88	73.2	1.59	40.4
△ G34100-1616B	16C5-16RMPB	7236-03065	7/8	22.2	1-11 1/2	1 3/8	2.91	73.9	1.72	43.7

⚠ WARNING: Cancer and Reproductive Harm - www.P65Warnings.ca.gov



### Male O-Ring Boss - Steel

DOT FMVSS 106-74 Type AII.

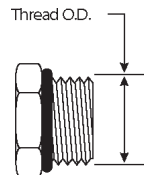
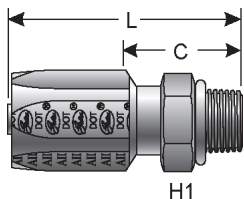

Part No.	Descr.	Prod. No.	⊘		H1	L		C		
			"	mm		"	mm	"	mm	
G34120-0404	4C5-4RMB	7236-86451	3/16	4.8	7/16-20	5/8	1.66	42.2	.94	23.9
G34120-0606	6C5-6RMB	7236-86453	5/16	7.9	9/16-18	11/16	2.00	50.8	1.05	26.7
G34120-0808	8C5X-8RMB	7237-00635	13/32	10.3	3/4-16	15/16	2.35	59.7	1.19	30.2

### Male JIC 37° Flare - Steel

DOT FMVSS 106-74 Type AII.

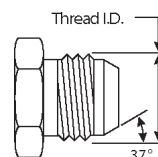
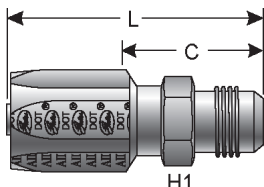

Part No.	Descr.	Prod. No.	⊘		H1	L		C		
			"	mm		"	mm	"	mm	
G34165-0404	4C5-4RMJ	7236-86431	3/16	4.8	7/16-20	1/2	1.79	45.5	1.09	27.7
G34165-0505	5C5X-5RMJ	7237-00655	1/4	6.4	1/2-20	1/2	1.96	49.8	1.19	30.2
G34165-0606	6C5-6RMJ	7236-86433	5/16	7.9	9/16-18	9/16	2.17	55.1	1.22	31.0
G34165-0808	8C5X-8RMJ	7237-00675	13/32	10.3	3/4-16	3/4	2.56	65.0	1.44	36.6
G34165-1010	10C5-10RMJ	7236-86435	1/2	12.7	7/8-14	7/8	2.88	73.2	1.59	40.4
G34165-1212	12C5X-12RMJ	7237-00695	5/8	15.9	1 1/16-12	1 1/16	3.34	84.8	1.78	45.2
G34165-1616	16C5-16RMJ	7236-86437	7/8	22.2	1 5/16-12	1 5/16	2.87	72.9	1.69	42.9

### Female JIC 37° Flare Swivel - Steel

DOT FMVSS 106-74 Type AII.

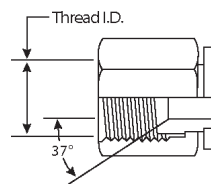
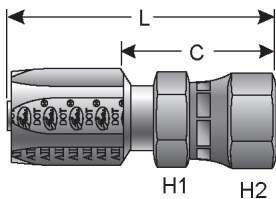

Part No.	Descr.	Prod. No.	⊘		H1	H2	L		C		
			"	mm			"	mm	"	mm	
G34170-0606	6C5-6RFJX	7238-86443	5/16	7.9	9/16-18	3/4	3/4	2.39	60.7	1.44	36.6
G34170-0806	8C5X-6RFJX	7237-00415	13/32	10.3	9/16-18	3/4	3/4	2.66	67.6	1.54	39.1

EQUIPMENT
HOSE/CPLG. SELECTION
G8K COUPLINGS
GLOBALSPIRAL COUPLINGS
STAINLESS STEEL SPIRAL
MEGACRIMP COUPLINGS
STAINLESS STEEL BRAID
POWER CRIMP COUPLINGS
FIELD ATTACHABLE G1 & G2 COUPLINGS
FIELD ATTACHABLE C5 COUPLINGS
C14 COUPLINGS
GL COUPLINGS
GLX COUPLINGS
PCTS THERMOPLASTIC COUPLINGS
POLARSEAL COUPLINGS (ACA)
POLARSEAL II COUPLINGS (ACC)
POLARSEAL II COUPLINGS (ACB)
POWER STEERING
ADAPTERS
QUICK DISCONNECT COUPLERS
BALL VALVES
LIVE SWIVEL
ASSEMBLY FABRICATION
ACCESSORIES
EQUIPMENT AND PARTS
KITS
AIR BRAKE HOSE ASSY
BRASS



EQUIPMENT
HOSE/CPLG. SELECTION
G8K COUPLINGS
GLOBAL SPIRAL COUPLINGS
STAINLESS STEEL SPIRAL
MEGACRIMP COUPLINGS
STAINLESS STEEL BRAID
POWER CRIMP COUPLINGS
FIELD ATTACHABLE G1 & G2 COUPLINGS
FIELD ATTACHABLE C5 COUPLINGS
C14 COUPLINGS
GL COUPLINGS
GLX COUPLINGS
PCTS THERMOPLASTIC COUPLINGS
POLARSEAL COUPLINGS (ACA)
POLARSEAL II COUPLINGS (ACC)
POLARSEAL II COUPLINGS (ACB)
POWER STEERING
ADAPTERS
QUICK DISCONNECT COUPLERS
BALL VALVES
LIVE SWIVEL
ASSEMBLY FABRICATION
ACCESSORIES
EQUIPMENT AND PARTS
KITS
AIR BRAKE HOSE ASSY
BRASS

### Female JIC 37° Flare Swivel - Steel - Continued

Part No.	Descr.	Prod. No.	⊖		H1	H2	L		C		
			"	mm			"	mm	"	mm	"
G34170-1012	10C5-12RFJX	7238-04325	1/2	12.7	1 1/16-12	1 1/4	1 1/4	3.22	81.8	1.93	49.0
G34170-1212	12C5X-12RFJX	7237-00455	5/8	15.9	1 1/16-12	1 1/4	1 1/4	3.50	88.9	1.94	49.3
G34170-1616	16C5-16RFJX	7238-86447	7/8	22.2	1 5/16-12	1 1/2	1 1/2	3.12	79.3	1.94	49.3
G34170-2020	20C5-20RFJX	7238-86394	1 1/8	28.6	1 5/8-12	2	2	3.56	90.4	2.19	55.6
G34170-2424	24C5-24RFJX	7238-86395	1 3/8	34.9	1 7/8-12	2 1/4	2 1/4	3.79	96.3	2.37	60.2
G34170-3232	32C5-32RFJX	7238-86396	1 13/16	46.0	2 1/2-12	2 1/2	2 7/8	4.99	126.8	2.72	69.1

### Female JIC 37° Flare Swivel - Brass

DOT FMVSS 106-74 Type All.

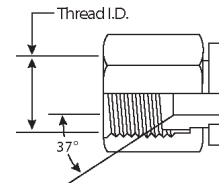
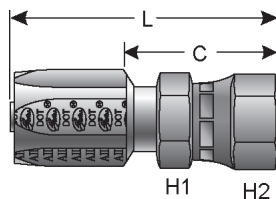

Part No.	Descr.	Prod. No.	⊖		H1	H2	L		C		
			"	mm			"	mm	"	mm	"
△ G34170-0606B	6C5-6RFJXB	7238-04075	5/16	7.9	9/16-18	3/4	3/4	2.39	60.7	1.44	36.6
△ G34170-1212B	12C5-12RFJXB	7238-04085	5/8	15.9	1 1/16-12	1 1/4	1 1/4	3.50	88.9	1.94	49.3
△ G34170-1616B	16C5-16RFJXB	7238-04095	7/8	22.2	1 5/16-12	1 1/2	1 1/2	3.12	79.3	1.94	49.3

⚠ WARNING: Cancer and Reproductive Harm - www.P65Warnings.ca.gov

### Female JIC 37° Flare Swivel - 45° Bent Tube - Steel

DOT FMVSS 106-74 Type All.

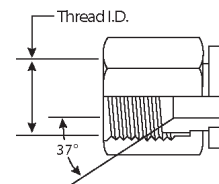
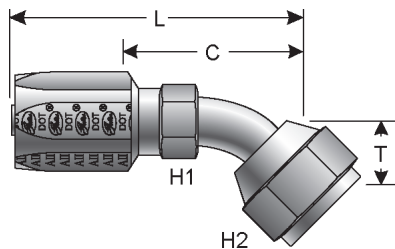

Part No.	Descr.	Prod. No.	⊖		H1	H2	T		L		C		
			"	mm			"	mm	"	mm	"	mm	
G34175-0606	6C5-6RFJX45	7235-86464	5/16	7.9	9/16-18	1/2	11/16	.41	10.4	2.40	61.0	1.45	36.8
G34175-1212	12C5X-12RFJX45S	7237-00535	5/8	15.9	1 1/16-12	7/8	1 1/4	.78	19.8	4.27	108.5	2.71	68.8
G34175-1616	16C5-16RFJX45	7235-86468	7/8	22.2	1 5/16-12	—	1 1/2	.88	22.4	4.03	102.4	2.84	72.1



## Female JIC 37° Flare Swivel - 90° Bent Tube - Steel

DOT FMVSS 106-74 Type All.

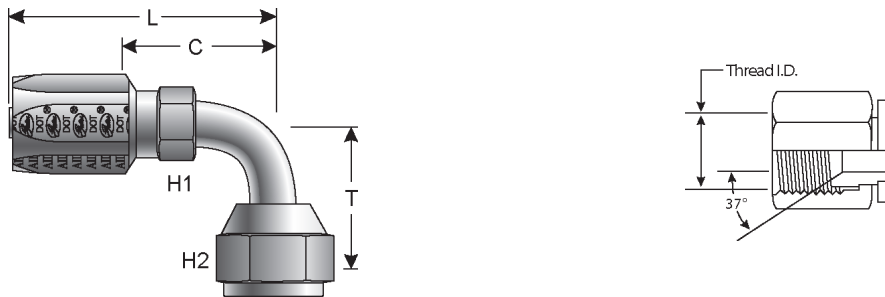

Part No.	Descr.	Prod. No.	⊖		🌀	H1	H2	T		L		C	
			"	mm				"	mm	"	mm	"	mm
G34180-0606	6C5-6RFJX90	7235-86471	5/16	7.9	9/16-18	1/2	11/16	.84	21.3	2.28	57.9	1.33	33.8
G34181-0606	6C5-6RFJX90L	7235-04205	5/16	7.9	9/16-18	1/2	11/16	2.19	55.6	2.28	57.9	1.33	33.8
G34180-1212	12C5X-12RFJX90S	7237-00545	5/8	15.9	1 1/16-12	7/8	1 1/4	1.81	46.0	4.22	107.2	2.66	67.6
G34181-1212	12C5X-12RFJX90L	7237-00555	5/8	15.9	1 1/16-12	7/8	1 1/4	3.75	95.3	4.22	107.2	2.66	67.6
G34180-1616	16C5-16RFJX90	7235-86475	7/8	22.2	1 5/16-12	—	1 1/2	2.16	54.9	3.95	100.3	2.76	70.1
G34181-1616	16C5-16RFJX90L	7235-86482	7/8	22.2	1 5/16-12	—	1 1/2	4.34	110.2	3.95	100.3	2.76	70.1
G34179-2020	20C5-20RFJX90S	7235-20265	1 1/8	28.6	1 5/8-12	—	2	2.75	69.9	5.07	128.8	3.70	94.0
G34181-2020	20C5-20RFJX90L	7235-20255	1 1/8	28.6	1 5/8-12	—	2	5.50	139.7	5.26	133.6	3.89	98.8

## Male SAE 45° Flare - Steel

DOT FMVSS 106-74 Type All.



Part No.	Descr.	Prod. No.	⊖		🌀	H1	L		C	
			"	mm			"	mm	"	mm
G34195-0404	4C5-4RMS	7236-86414	3/16	4.8	7/16-20	1/2	1.76	44.7	1.06	26.9
G34195-0505	5C5X-5RMS	7237-00725	1/4	6.4	1/2-20	1/2	1.96	49.8	1.19	30.2
G34195-0606	6C5-6RMS	7236-86416	5/16	7.9	5/8-18	5/8	2.23	56.6	1.28	32.5
G34195-0808	8C5X-8RMS	7237-00745	13/32	10.3	3/4-16	3/4	2.65	67.3	1.53	38.9
G34195-1010	10C5-10RMS	7236-86418	1/2	12.7	7/8-14	7/8	3.01	76.5	1.72	43.7
G34195-1212	12C5X-12RMS	7237-00765	5/8	15.9	1 1/16-14	1 1/16	3.50	88.9	1.94	49.3

EQUIPMENT
HOSE/CPLG. SELECTION
G8K COUPLINGS
GLOBALSPIRAL COUPLINGS
STAINLESS STEEL SPIRAL
MEGACRIMP COUPLINGS
STAINLESS STEEL BRAID
POWER CRIMP COUPLINGS
FIELD ATTACHABLE G1 & G2 COUPLINGS
FIELD ATTACHABLE C5 COUPLINGS
C14 COUPLINGS
GL COUPLINGS
GLX COUPLINGS
PCTS THERMOPLASTIC COUPLINGS
POLARSEAL COUPLINGS (ACA)
POLARSEAL II COUPLINGS (ACC)
POLARSEAL II COUPLINGS (ACB)
POWER STEERING
ADAPTERS
QUICK DISCONNECT COUPLERS
BALL VALVES
LIVE SWIVEL
ASSEMBLY FABRICATION
ACCESSORIES
EQUIPMENT AND PARTS
KITS
AIR BRAKE HOSE ASSY
BRASS



EQUIPMENT
HOSE/CPLG. SELECTION
G8K COUPLINGS
GLOBAL SPIRAL COUPLINGS
STAINLESS STEEL SPIRAL
MEGACRIMP COUPLINGS
STAINLESS STEEL BRAID
POWER CRIMP COUPLINGS
FIELD ATTACHABLE G1 & G2 COUPLINGS
FIELD ATTACHABLE C5 COUPLINGS
C14 COUPLINGS
GL COUPLINGS
GLX COUPLINGS
PCTS THERMOPLASTIC COUPLINGS
POLARSEAL COUPLINGS (ACA)
POLARSEAL II COUPLINGS (ACC)
POLARSEAL II COUPLINGS (ACB)
POWER STEERING
ADAPTERS
QUICK DISCONNECT COUPLERS
BALL VALVES
LIVE SWIVEL
ASSEMBLY FABRICATION
ACCESSORIES
EQUIPMENT AND PARTS
KITS
AIR BRAKE HOSE ASSY
BRASS

### Female SAE 45° Flare Swivel - Steel

DOT FMVSS 106-74 Type All.

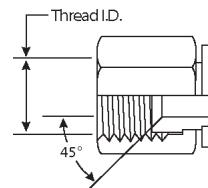
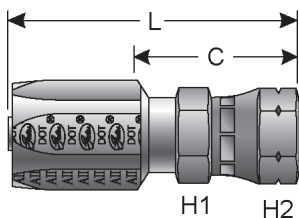

Part No.	Descr.	Prod. No.	⊖		🌀	H1	H2	L		C	
			"	mm				"	mm	"	mm
G34200-0606	6C5-6RFSX	7238-04235	5/16	7.9	5/8-18	3/4	3/4	2.42	61.5	1.47	37.3
G34200-1012	10C5-12RFSX	7238-04335	1/2	12.7	1 1/16-14	1 1/4	1 1/4	3.22	81.8	1.93	49.0
G34200-1212	12C5X-12RFSX	7237-00795	5/8	15.9	1 1/16-14	1 1/4	1 1/4	3.50	88.9	1.94	49.3

### Female SAE 45° Flare Swivel - Brass

DOT FMVSS 106-74 Type All.

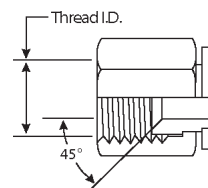
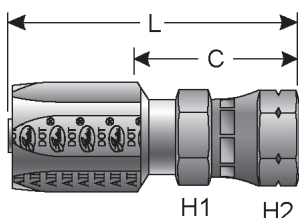

Part No.	Descr.	Prod. No.	⊖		🌀	H1	H2	L		C	
			"	mm				"	mm	"	mm
△ G34200-0606B	6C5-6RFSXB	7238-04045	5/16	7.9	5/8-18	3/4	3/4	2.42	61.5	1.47	37.3
△ G34200-1212B	12C5-12RFSXB	7238-04055	5/8	15.9	1 1/16-14	1 1/4	1 1/4	3.50	88.9	1.94	49.3

△ WARNING: Cancer and Reproductive Harm - www.P65Warnings.ca.gov

### Female SAE 45° Flare Swivel - 45° Bent Tube - Steel

DOT FMVSS 106-74 Type All.

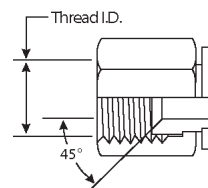
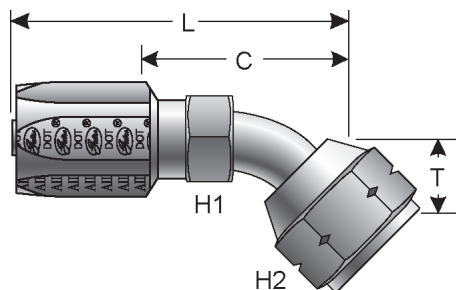

Part No.	Descr.	Prod. No.	⊖		🌀	H1	H2	T		L		C	
			"	mm				"	mm	"	mm	"	mm
G34202-0606	6C5-6RFSX45	7235-04855	5/16	7.9	5/8-18	1/2	3/4	.41	10.4	2.42	61.5	1.47	37.3



Female SAE 45° Flare Swivel - 45° Bent Tube - Steel - Continued

Part No.	Descr.	Prod. No.	⊖		H1	H2	T		L		C		
			"	mm			"	"	"	mm	"	mm	"
G34202-1212	12C5X-12RFSX45S	7237-00835	5/8	15.9	1 1/16-14	7/8	1 1/4	.74	18.9	4.27	108.5	2.71	68.8

Female SAE 45° Flare Swivel - 90° Bent Tube - Steel

DOT FMVSS 106-74 Type All.

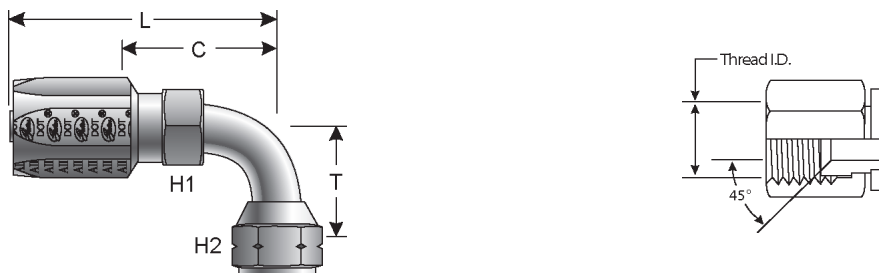

Part No.	Descr.	Prod. No.	⊖		H1	H2	T		L		C		
			"	mm			"	"	"	mm	"	mm	"
G34205-0606	6C5-6RFSX90	7235-04915	5/16	7.9	5/8-18	1/2	3/4	.84	21.3	2.28	57.9	1.33	33.8
G34206-0606	6C5-6RFSX90L	7235-86497	5/16	7.9	5/8-18	1/2	3/4	2.19	55.6	2.28	57.9	1.22	31.0
G34205-1212	12C5X-12RFSX90S	7237-00845	5/8	15.9	1 1/16-14	7/8	1 1/4	1.81	46.0	4.72	119.9	2.66	67.6
G34206-1212	12C5X-12RFSX90L	7237-00855	5/8	15.9	1 1/16-14	7/8	1 1/4	3.75	95.3	4.22	107.2	2.16	54.9

Dual Seat Female JIC 37°/SAE 45° Flare Swivel - Steel

DOT FMVSS 106-74 Type All.

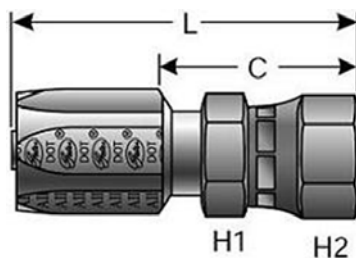

Part No.	Descr.	Prod. No.	⊖		H1	H2	L		C		
			"	mm			"	"	"	mm	"
G34210-0404	4C5-4RFJSX	7238-04215	3/16	4.8	7/16-20	9/16	9/16	1.92	48.8	1.22	31.0
G34210-0504	5C5X-4RFJSX	7237-00875	1/4	6.4	7/16-20	9/16	9/16	2.05	52.1	1.28	32.5
G34210-0505	5C5X-5RFJSX	7237-00885	1/4	6.4	1/2-20	11/16	11/16	2.11	53.6	1.34	34.0
G34210-0608	6C5-8RFJSX	7238-04295	5/16	7.9	3/4-16	7/8	7/8	2.48	63.0	1.53	38.9
G34210-0808	8C5X-8RFJSX	7237-00905	13/32	10.3	3/4-16	7/8	7/8	2.75	69.9	1.63	41.4
G34210-1008	10C5-8RFJSX	7238-04315	1/2	12.7	3/4-16	7/8	7/8	2.93	74.4	1.64	41.7
G34210-1010	10C5-10RFJSX	7238-04255	1/2	12.7	7/8-14	1 1/16	1 1/16	3.10	78.7	1.81	46.0

- EQUIPMENT
- HOSE/CPLG. SELECTION
- G8K COUPLINGS
- GLOBAL SPIRAL COUPLINGS
- STAINLESS STEEL SPIRAL
- MEGACRIMP COUPLINGS
- STAINLESS STEEL BRAID
- POWER CRIMP COUPLINGS
- FIELD ATTACHABLE G1 & G2 COUPLINGS
- FIELD ATTACHABLE C5 COUPLINGS
- C14 COUPLINGS
- GL COUPLINGS
- GLX COUPLINGS
- PCTS THERMOPLASTIC COUPLINGS
- POLARSEAL COUPLINGS (ACA)
- POLARSEAL II COUPLINGS (ACC)
- POLARSEAL II COUPLINGS (ACB)
- POWER STEERING
- ADAPTERS
- QUICK DISCONNECT COUPLERS
- BALL VALVES
- LIVE SWIVEL
- ASSEMBLY FABRICATION
- ACCESSORIES
- EQUIPMENT AND PARTS
- KITS
- AIR BRAKE HOSE ASSY
- BRASS



## Dual Seat Female JIC 37°/SAE 45° Flare Swivel - Brass

DOT FMVSS 106-74 Type All.

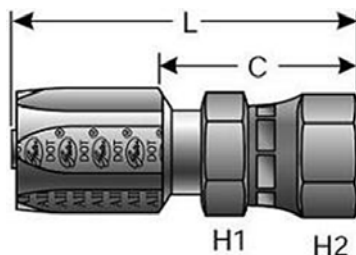

Part No.	Descr.	Prod. No.	⊖		🌀	H1	H2	L		C	
			"	mm				"	mm	"	mm
△ G34210-0505B	5C5-5RFJSXB	7238-04005	1/4	6.4	1/2-20	11/16	11/16	2.11	53.6	1.34	34.0
△ G34210-0808B	8C5-8RFJSXB	7238-04015	13/32	10.3	3/4-16	7/8	7/8	2.75	69.9	1.63	41.4
△ G34210-1010B	10C5-10RFJSXB	7238-04025	1/2	12.7	7/8-14	1 1/16	1 1/16	3.10	78.7	1.81	46.0

⚠️ WARNING: Cancer and Reproductive Harm - www.P65Warnings.ca.gov

## Dual Seat Female JIC 37°/SAE 45° Flare Swivel - 45° Bent Tube - Steel

DOT FMVSS 106-74 Type All.

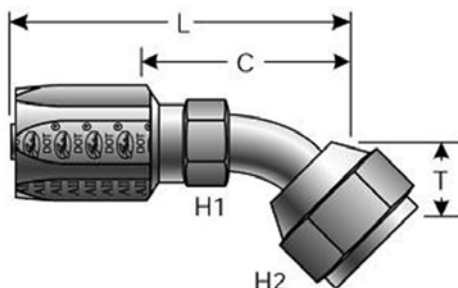

Part No.	Descr.	Prod. No.	⊖		🌀	H1	H2	T		L		C	
			"	mm				"	mm	"	mm	"	mm
G34211-0404	4C5-4RFJSX45	7235-20005	3/16	4.8	7/16-20	7/16	9/16	.34	8.6	1.90	48.3	1.21	30.7
G34211-0505	5C5X-5RFJSX45S	7237-00945	1/4	6.4	1/2-20	7/16	5/8	.38	9.7	2.11	53.6	1.34	34.0
G34211-0608	6C5-8RFJSX45	7235-20045	5/16	7.9	3/4-16	5/8	7/8	.56	14.2	2.71	68.8	1.76	44.7
G34211-0808	8C5X-8RFJSX45S	7237-00965	13/32	10.3	3/4-16	5/8	7/8	.56	14.2	2.98	75.7	1.86	47.2
G34211-1010	10C5-10RFJSX45	7235-20035	1/2	12.7	7/8-14	3/4	1	.63	16.0	3.60	91.4	2.31	58.7

EQUIPMENT
HOSE/CPLG. SELECTION
G8K COUPLINGS
GLOBAL SPIRAL COUPLINGS
STAINLESS STEEL SPIRAL
MEGACRIMP COUPLINGS
STAINLESS STEEL BRAID
POWER CRIMP COUPLINGS
FIELD ATTACHABLE G1 & G2 COUPLINGS
FIELD ATTACHABLE C5 COUPLINGS
C14 COUPLINGS
GL COUPLINGS
GLX COUPLINGS
PCTS THERMOPLASTIC COUPLINGS
POLARSEAL COUPLINGS (ACA)
POLARSEAL II COUPLINGS (ACC)
POLARSEAL II COUPLINGS (ACB)
POWER STEERING
ADAPTERS
QUICK DISCONNECT COUPLERS
BALL VALVES
LIVE SWIVEL
ASSEMBLY FABRICATION
ACCESSORIES
EQUIPMENT AND PARTS
KITS
AIR BRAKE HOSE ASSY
BRASS



FIELD ATTACHABLE FOR C5CXH, C5C, C5D & C5M HOSE

## Dual Seat Female JIC 37°/SAE 45° Flare Swivel - 90° Bent Tube - Steel

DOT FMVSS 106-74 Type All.

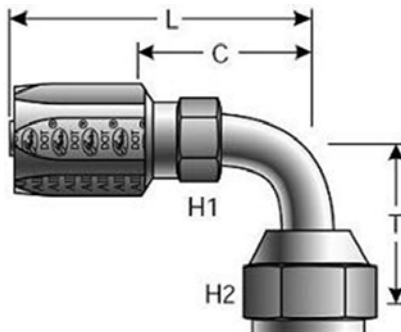

Part No.	Descr.	Prod. No.	⊖		🌀	H1	H2	T		L		C	
			"	mm				"	mm	"	mm	"	mm
G34212-0404	4C5-4RFJSX90	7235-20105	3/16	4.8	7/16-20	7/16	9/16	.69	17.5	1.78	45.2	1.08	27.4
G34213-0404	4C5-4RFJSX90L	7235-20205	3/16	4.8	7/16-20	7/16	9/16	1.81	46.0	1.78	45.2	1.08	27.4
G34212-0505	5C5X-5RFJSX90S	7237-01005	1/4	6.4	1/2-20	7/16	5/8	.78	19.8	2.02	51.3	1.25	31.8
G34213-0505	5C5X-5RFJSX90L	7237-01015	1/4	6.4	1/2-20	7/16	5/8	1.78	45.2	2.02	51.3	1.25	31.8
G34212-0808	8C5X-8RFJSX90S	7237-01025	13/32	10.3	3/4-16	5/8	7/8	1.09	27.7	2.79	70.9	1.67	42.4
G34213-0808	8C5X-8RFJSX90L	7237-01035	13/32	10.3	3/4-16	5/8	7/8	2.44	62.0	2.79	70.9	1.67	42.4
G34212-1010	10C5-10RFJSX90	7235-20135	1/2	12.7	7/8-14	3/4	1	1.25	31.8	3.41	86.6	2.12	53.9
G34213-1010	10C5-10RFJSX90L	7235-20235	1/2	12.7	7/8-14	3/4	1	2.56	65.0	3.41	86.6	2.12	53.9

## Female Flat-Face Swivel - Steel

DOT FMVSS 106-74 Type All.  
SAE J1453 O-Ring Face Seal.



Part No.	Descr.	Prod. No.	⊖		🌀	H1	H2	L		C	
			"	mm				"	mm	"	mm
G34230-0404	4C5-4RFFORX	7238-01505	3/16	4.8	9/16-18	9/16	11/16	2.07	52.6	1.32	33.5
G34230-0606	6C5-6RFFORX	7238-01265	5/16	7.9	11/16-16	1/2	13/16	2.53	64.3	1.58	40.1
G34230-0808	8C5X-8RFFORX	7237-01085	13/32	10.3	13/16-16	13/16	15/16	2.92	74.2	1.77	45.0
G34230-1010	10C5-10RFFORX	7238-01545	1/2	12.7	1-14	15/16	1 1/8	3.23	82.0	1.94	49.3
G34230-1212	12C5X-12RFFORX	7237-01105	5/8	15.9	1 3/16-12	7/8	1 3/8	3.70	94.0	2.12	53.9

EQUIPMENT
HOSE/CPLG. SELECTION
G8K COUPLINGS
GLOBALSPIRAL COUPLINGS
STAINLESS STEEL SPIRAL
MEGACRIMP COUPLINGS
STAINLESS STEEL BRAID
POWER CRIMP COUPLINGS
FIELD ATTACHABLE G1 & G2 COUPLINGS
FIELD ATTACHABLE C5 COUPLINGS
C14 COUPLINGS
GL COUPLINGS
GLX COUPLINGS
PCTS THERMOPLASTIC COUPLINGS
POLARSEAL COUPLINGS (ACA)
POLARSEAL II COUPLINGS (ACC)
POLARSEAL II COUPLINGS (ACB)
POWER STEERING
ADAPTERS
QUICK DISCONNECT COUPLERS
BALL VALVES
LIVE SWIVEL
ASSEMBLY FABRICATION
ACCESSORIES
EQUIPMENT AND PARTS
KITS
AIR BRAKE HOSE ASSY
BRASS



EQUIPMENT
HOSE/CPLG. SELECTION
G8K COUPLINGS
GLOBAL SPIRAL COUPLINGS
STAINLESS STEEL SPIRAL
MEGACRIMP COUPLINGS
STAINLESS STEEL BRAID
POWER CRIMP COUPLINGS
FIELD ATTACHABLE G1 & G2 COUPLINGS
FIELD ATTACHABLE C5 COUPLINGS
C14 COUPLINGS
GL COUPLINGS
GLX COUPLINGS
PCTS THERMOPLASTIC COUPLINGS
POLARSEAL COUPLINGS (ACA)
POLARSEAL II COUPLINGS (ACC)
POLARSEAL II COUPLINGS (ACB)
POWER STEERING
ADAPTERS
QUICK DISCONNECT COUPLERS
BALL VALVES
LIVE SWIVEL
ASSEMBLY FABRICATION
ACCESSORIES
EQUIPMENT AND PARTS
KITS
AIR BRAKE HOSE ASSY
BRASS

### Female Flat-Face Swivel - 45° Bent Tube - Steel

DOT FMVSS 106-74 Type All.  
SAE J1453 O-Ring Face Seal.

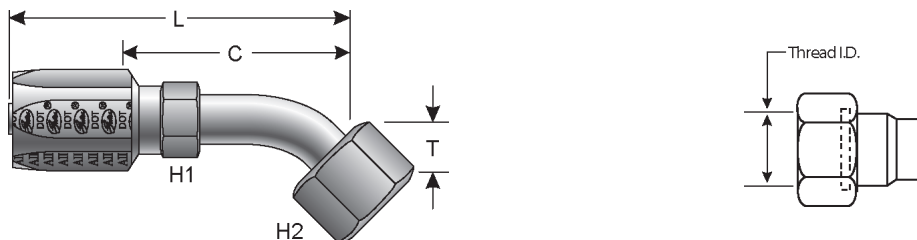

Part No.	Descr.	Prod. No.	⌀		H1	H2	T		L		C		
			"	mm			"	mm	"	mm	"	mm	
G34235-0404	4C5-4RFFORX45	7235-05275	3/16	4.8	9/16-18	1/2	11/16	.41	10.4	2.42	61.5	1.67	42.4

### Female Flat-Face Swivel - 90° Bent Tube - Steel

DOT FMVSS 106-74 Type All.  
SAE J1453 O-Ring Face Seal.

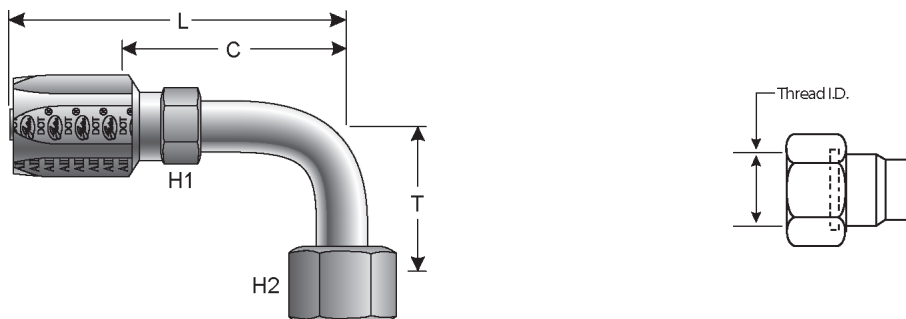

Part No.	Descr.	Prod. No.	⌀		H1	H2	T		L		C		
			"	mm			"	mm	"	mm	"	mm	
G34240-0404	4C5-4RFFORX90	7235-05285	3/16	4.8	9/16-18	1/2	11/16	.82	20.8	2.17	55.1	1.42	36.1
G34239-0606	6C5-6RFFORX90S	7235-05305	5/16	7.9	11/16-16	1/2	13/16	.90	22.9	2.77	70.4	1.82	46.2



## Special Flange - 90° - Engine Oil Connection (Code 61 2-Bolt)

DOT FMVSS 106-74 Type All.

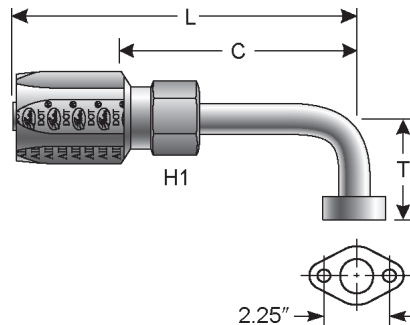

Part No.	Descr.	Prod. No.	⌀		H1	T		L		C	
			"	mm		"	mm	"	mm	"	mm
G34342-2020	20C5-20RFL90S	7235-20275	1 1/8	28.6	1 9/16	2.50	63.5	4.95	125.7	3.95	100.3

## Male SAE 45° Flare Inverted Swivel - Steel

DOT FMVSS 106-74 Type All.



Part No.	Descr.	Prod. No.	⌀		H1	H2	L		C		
			"	mm			"	mm	"	mm	
G34500-0404	4C5-4RMIX	7235-86372	3/16	4.8	7/16-24	7/16	7/16	2.41	61.2	1.72	43.7
G34500-0505	5C5X-5RMIX	7237-01155	1/4	6.4	1/2-20	7/16	1/2	2.63	66.8	1.84	46.7
G34500-0506	5C5X-6RMIX	7237-01165	1/4	6.4	5/8-18	1/2	5/8	2.59	65.8	1.82	46.2
G34500-0605	6C5-5RMIX	7235-01035	5/16	7.9	1/2-20	1/2	1/2	2.60	66.0	1.65	41.9
G34500-0606	6C5-6RMIX	7235-86382	5/16	7.9	5/8-18	1/2	5/8	2.86	72.6	1.91	48.5
G34500-0608	6C5-8RMIX	7235-01055	5/16	7.9	3/4-18	5/8	3/4	3.23	82.0	2.28	57.9
G34500-0806	8C5X-6RMIX	7237-01205	13/32	10.3	5/8-18	5/8	5/8	3.13	79.5	2.01	51.1
G34500-0808	8C5X-8RMIX	7237-01215	13/32	10.3	3/4-18	5/8	3/4	3.49	88.7	2.37	60.2

EQUIPMENT
HOSE/CPLG. SELECTION
G8K COUPLINGS
GLOBALSPIRAL COUPLINGS
STAINLESS STEEL SPIRAL
MEGACRIMP COUPLINGS
STAINLESS STEEL BRAID
POWER CRIMP COUPLINGS
FIELD ATTACHABLE G1 & G2 COUPLINGS
FIELD ATTACHABLE C5 COUPLINGS
C14 COUPLINGS
GL COUPLINGS
GLX COUPLINGS
PCTS THERMOPLASTIC COUPLINGS
POLARSEAL COUPLINGS (ACA)
POLARSEAL II COUPLINGS (ACC)
POLARSEAL II COUPLINGS (ACB)
POWER STEERING
ADAPTERS
QUICK DISCONNECT COUPLERS
BALL VALVES
LIVE SWIVEL
ASSEMBLY FABRICATION
ACCESSORIES
EQUIPMENT AND PARTS
KITS
AIR BRAKE HOSE ASSY
BRASS



EQUIPMENT
HOSE/CPLG. SELECTION
G8K COUPLINGS
GLOBAL SPIRAL COUPLINGS
STAINLESS STEEL SPIRAL
MEGACRIMP COUPLINGS
STAINLESS STEEL BRAID
POWER CRIMP COUPLINGS
FIELD ATTACHABLE G1 & G2 COUPLINGS
FIELD ATTACHABLE C5 COUPLINGS
C14 COUPLINGS
GL COUPLINGS
GLX COUPLINGS
PCTS THERMOPLASTIC COUPLINGS
POLARSEAL COUPLINGS (ACA)
POLARSEAL II COUPLINGS (ACC)
POLARSEAL II COUPLINGS (ACB)
POWER STEERING
ADAPTERS
QUICK DISCONNECT COUPLERS
BALL VALVES
LIVE SWIVEL
ASSEMBLY FABRICATION
ACCESSORIES
EQUIPMENT AND PARTS
KITS
AIR BRAKE HOSE ASSY
BRASS

## Male SAE 45° Flare Inverted Swivel - 45° Bent Tube - Steel

DOT FMVSS 106-74 Type All.

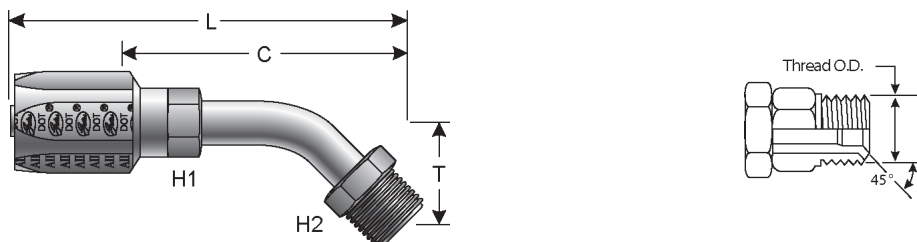

Part No.	Descr.	Prod. No.	⌀		H1	H2	T		L		C		
			"	mm			"	mm	"	mm	"	mm	
G34502-0404	4C5-4RMIX45	7235-05005	3/16	4.8	7/16-24	7/16	7/16	.62	15.8	2.18	55.4	1.48	37.6
G34502-0606	6C5-6RMIX45	7235-05015	5/16	7.9	5/8-18	1/2	5/8	.94	23.9	3.03	77.0	2.09	53.1
G34502-0808	8C5X-8RMIX45-028	7237-01245	13/32	10.3	3/4-18	5/8	3/4	1.09	27.7	3.44	87.4	2.32	58.9

## Male SAE 45° Flare Inverted Swivel - 90° Bent Tube - Steel

DOT FMVSS 106-74 Type All.

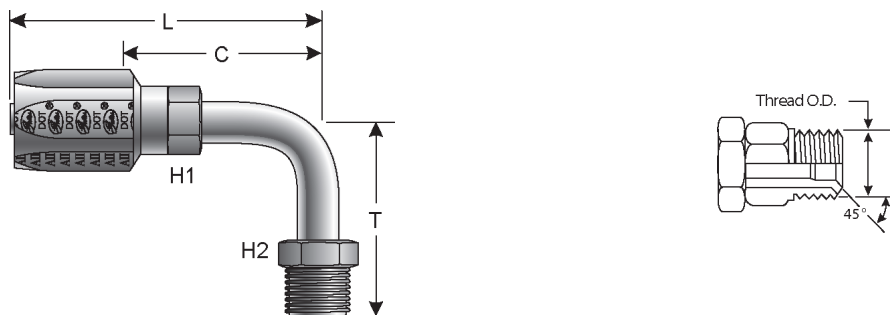

Part No.	Descr.	Prod. No.	⌀		H1	H2	T		L		C		
			"	mm			"	mm	"	mm	"	mm	
G34504-0404	4C5-4RMIX90	7235-05105	3/16	4.8	7/16-24	7/16	7/16	1.56	39.6	2.17	55.1	1.47	37.3
G34504-0505	5C5X-5RMIX90-042	7237-01265	1/4	6.4	1/2-20	7/16	1/2	1.66	42.2	2.43	61.7	1.66	42.2
G34504-0606	6C5-6RMIX90	7235-86387	5/16	7.9	5/8-18	1/2	5/8	1.69	42.9	2.64	67.1	1.69	42.9
G34504-0608	6C5-8RMIX90	7235-05135	5/16	7.9	3/4-18	5/8	3/4	1.78	45.2	2.73	69.3	1.78	45.2
G34504-0806	8C5X-6RMIX90-043	7237-01295	13/32	10.3	5/8-18	5/8	5/8	1.69	42.9	2.81	71.4	1.69	42.9
G34504-0808	8C5X-8RMIX90-045	7237-01305	13/32	10.3	3/4-18	5/8	3/4	1.78	45.2	2.90	73.7	1.78	45.2



## SAE Male Flareless Assembly - Steel

DOT FMVSS 106-74 Type All.

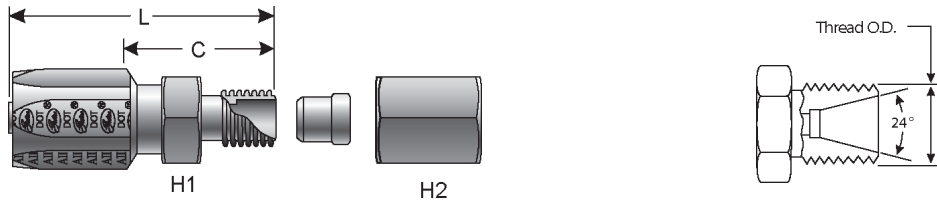

Part No.	Descr.	Prod. No.	⌀		H1	H2	L		C		
			"	mm			"	"	"	mm	"
G34510-0404	4C5-4RMFA	7236-04855	3/16	4.8	7/16-20	1/2	9/16	1.81	46.0	1.06	26.9
G34510-0505	5C5X-5RMFA	7237-01325	1/4	6.4	1/2-20	9/16	5/8	1.91	48.5	1.12	28.5
G34510-0604	6C5-4RMFA	7236-04875	5/16	7.9	7/16-20	9/16	9/16	2.03	51.6	1.13	28.7
G34510-0606	6C5-6RMFA	7236-04885	5/16	7.9	9/16-18	5/8	11/16	2.05	52.1	1.15	29.2
G34510-0808	8C5X-8RMFA	7237-01355	13/32	10.3	3/4-16	13/16	7/8	2.52	64.0	1.37	34.8
G34510-1010	10C5-10RMFA	7236-04905	1/2	12.7	7/8-14	15/16	1	2.77	70.4	1.48	37.6

## Female Air Brake Swivel - Steel

DOT FMVSS 106-74 Type All.

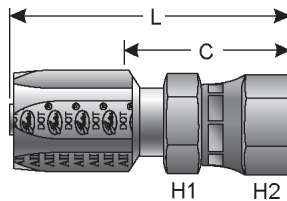

Part No.	Descr.	Prod. No.	⌀		H1	H2	L		C		
			"	mm			"	"	"	mm	"
G34540-0606	6C5-6RFABX	7238-04425	5/16	7.9	3/4-20	7/8	7/8	2.29	58.2	1.34	34.0
G34540-0806	8C5X-6RFABX	7237-01395	13/32	10.3	3/4-20	7/8	7/8	2.60	66.0	1.48	37.6

## Parker Triple Thread Female Swivel - Steel

DOT FMVSS 106-74 Type All.



Part No.	Descr.	Prod. No.	⌀		H1	H2	L		C		
			"	mm			"	"	"	mm	"
G34562-1616	16C5-16RFZX	7238-86461	7/8	22.2	1 5/16-14	1 1/2	1 1/2	2.90	73.7	1.72	43.7

- EQUIPMENT
- HOSE/CPLG. SELECTION
- G8K COUPLINGS
- GLOBALSPIRAL COUPLINGS
- STAINLESS STEEL SPIRAL
- MEGACRIMP COUPLINGS
- STAINLESS STEEL BRAID
- POWER CRIMP COUPLINGS
- FIELD ATTACHABLE G1 & G2 COUPLINGS
- FIELD ATTACHABLE C5 COUPLINGS
- C14 COUPLINGS
- GL COUPLINGS
- GLX COUPLINGS
- PCTS THERMOPLASTIC COUPLINGS
- POLARSEAL COUPLINGS (ACA)
- POLARSEAL II COUPLINGS (ACC)
- POLARSEAL II COUPLINGS (ACB)
- POWER STEERING
- ADAPTERS
- QUICK DISCONNECT COUPLERS
- BALL VALVES
- LIVE SWIVEL
- ASSEMBLY FABRICATION
- ACCESSORIES
- EQUIPMENT AND PARTS
- KITS
- AIR BRAKE HOSE ASSY
- BRASS



### Male Pipe (NPTF - 30° Cone Seat) - Steel

DOT FMVSS Type A1 (No mandrel required).

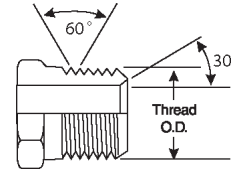
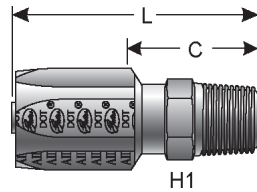

Part No.	Descr.	Prod. No.	⊖		🌀	H1	L		C	
			"	mm			"	mm	"	mm
G35100-0402	4C5E-2RMP	7236-00755	3/16	4.8	1/8-27	1/2	1.53	38.9	.81	20.6
G35100-0404	4C5E-4RMP	7236-00765	3/16	4.8	1/4-18	9/16	1.75	44.5	1.03	26.2
G35100-0504	5C5E-4RMP	7236-00775	1/4	6.4	1/4-18	9/16	1.76	44.7	.96	24.4
G35100-0604	6C5E-4RMP	7236-00785	5/16	7.9	1/4-18	9/16	1.85	47.0	1.00	25.4
G35100-0606	6C5E-6RMP	7236-00795	5/16	7.9	3/8-18	11/16	1.89	48.0	1.04	26.4
G35100-0806	8C5E-6RMP	7236-00805	13/32	10.3	3/8-18	11/16	2.19	55.6	1.19	30.2
G35100-0808	8C5E-8RMP	7236-00815	13/32	10.3	1/2-14	7/8	2.29	58.2	1.29	32.8
G35100-1008	10C5E-8RMP	7236-00825	1/2	12.7	1/2-14	7/8	2.38	60.5	1.31	33.3
G35100-1212	12C5E-12RMP	7236-00835	5/8	15.9	3/4-14	1 1/16	2.59	65.8	1.44	36.6
G35100-1216	12C5E-16RMP	7236-00845	5/8	15.9	1-11 1/2	1 3/8	2.87	72.9	1.72	43.7
G35100-1612	16C5E-12RMP	7236-00865	7/8	22.2	3/4-14	1 1/16	2.49	63.3	1.43	36.3
G35100-1616	16C5E-16RMP	7236-00855	7/8	22.2	1-11 1/2	1 3/8	2.80	71.1	1.74	44.2
G35100-2020	20C5E-20RMP	7236-00885	1 1/8	28.6	1 1/4-11 1/2	1 3/4	2.92	74.2	1.80	45.7

### Female JIC 37° Flare Swivel - Steel

DOT FMVSS Type A1 (No mandrel required).

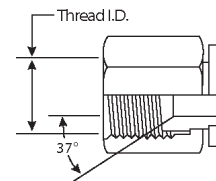
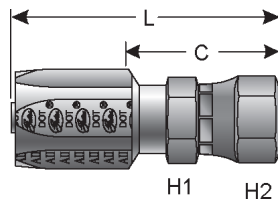

Part No.	Descr.	Prod. No.	⊖		🌀	H1	H2	L		C	
			"	mm				"	mm	"	mm
G35170-0606	6C5E-6RFJX	7238-01025	5/16	7.9	9/16-18	3/4	3/4	2.04	51.8	1.19	30.2
G35170-1212	12C5E-12RFJX	7238-01055	5/8	15.9	1 1/16-12	1 1/4	1 1/4	2.92	74.2	1.78	45.2
G35170-1616	16C5E-16RFJX	7238-01065	7/8	22.2	1 5/16-12	1 1/2	1 1/2	2.90	73.7	1.84	46.7
G35170-2020	20C5E-20RFJX	7238-01215	1 1/8	28.6	1 5/8-12	1 9/16	2	3.34	84.8	2.20	55.9



## Female JIC 37° Flare Swivel - 45° Bent Tube - Steel

DOT FMVSS Type A1 (No mandrel required).

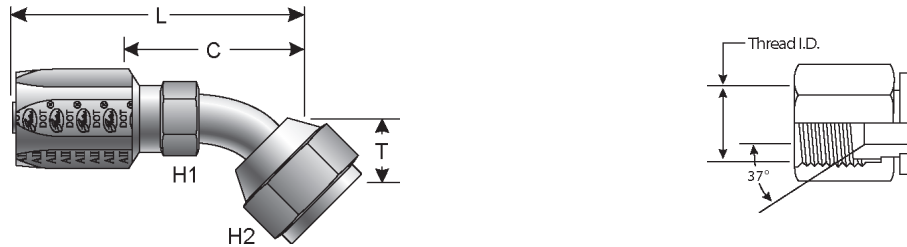

Part No.	Descr.	Prod. No.	⊖		H1	H2	T		L		C		
			"	mm			"	"	"	mm	"	mm	"
G35175-0606	6C5E-6RFJX45	7235-20415	5/16	7.9	9/16-18	1/2	11/16	.41	10.4	2.33	59.2	1.48	37.6
G35175-1212	12C5E-12RFJX45	7235-20455	5/8	15.9	1 1/16-12	7/8	1 1/4	.78	19.8	3.63	92.2	2.49	63.3

## Female JIC 37° Flare Swivel - 90° Bent Tube - Steel

DOT FMVSS Type A1 (No mandrel required).

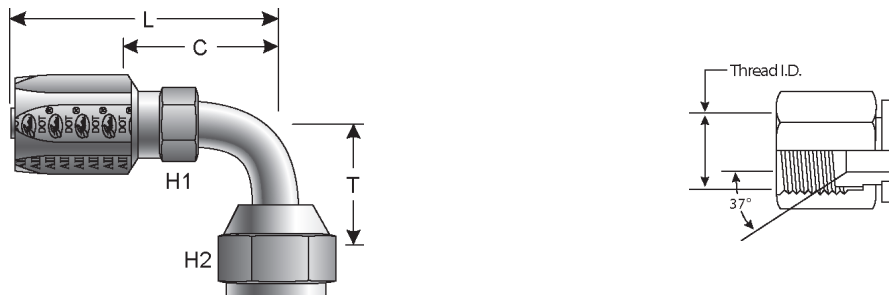

Part No.	Descr.	Prod. No.	⊖		H1	H2	T		L		C		
			"	mm			"	"	"	mm	"	mm	"
G35180-0606	6C5E-6RFJX90	7235-00305	5/16	7.9	9/16-18	1/2	11/16	.91	23.4	2.21	56.1	1.78	45.2
G35180-1212	12C5E-12RFJX90	7235-00265	5/8	15.9	1 1/16-12	7/8	1 1/4	1.81	46.0	3.58	90.9	2.44	62.0
G35180-1616	16C5E-16RFJX90	7235-00285	7/8	22.2	1 5/16-12	—	1 1/2	2.16	54.9	3.72	94.5	2.66	67.6
G35180-2020	20C5E-20RFJX90	7235-20345	1 1/8	28.6	1 5/8-12	2	1 9/16	2.65	67.3	5.58	141.7	4.45	113.0

EQUIPMENT
HOSE/CPLG. SELECTION
G8K COUPLINGS
GLOBALSPIRAL COUPLINGS
STAINLESS STEEL SPIRAL
MEGACRIMP COUPLINGS
STAINLESS STEEL BRAID
POWER CRIMP COUPLINGS
FIELD ATTACHABLE G1 & G2 COUPLINGS
FIELD ATTACHABLE C5 COUPLINGS
C14 COUPLINGS
GL COUPLINGS
GLX COUPLINGS
PCTS THERMOPLASTIC COUPLINGS
POLARSEAL COUPLINGS (ACA)
POLARSEAL II COUPLINGS (ACC)
POLARSEAL II COUPLINGS (ACB)
POWER STEERING
ADAPTERS
QUICK DISCONNECT COUPLERS
BALL VALVES
LIVE SWIVEL
ASSEMBLY FABRICATION
ACCESSORIES
EQUIPMENT AND PARTS
KITS
AIR BRAKE HOSE ASSY
BRASS



EQUIPMENT
HOSE/CPLG. SELECTION
G8K COUPLINGS
GLOBALSPIRAL COUPLINGS
STAINLESS STEEL SPIRAL
MEGACRIMP COUPLINGS
STAINLESS STEEL BRAID
POWER CRIMP COUPLINGS
FIELD ATTACHABLE G1 & G2 COUPLINGS
FIELD ATTACHABLE C5 COUPLINGS
C14 COUPLINGS
GL COUPLINGS
GLX COUPLINGS
PCTS THERMOPLASTIC COUPLINGS
POLARSEAL COUPLINGS (ACA)
POLARSEAL II COUPLINGS (ACC)
POLARSEAL II COUPLINGS (ACB)
POWER STEERING
ADAPTERS
QUICK DISCONNECT COUPLERS
BALL VALVES
LIVE SWIVEL
ASSEMBLY FABRICATION
ACCESSORIES
EQUIPMENT AND PARTS
KITS
AIR BRAKE HOSE ASSY
BRASS

### Female SAE 45° Flare Swivel - Steel

DOT FMVSS Type A1 (No mandrel required).

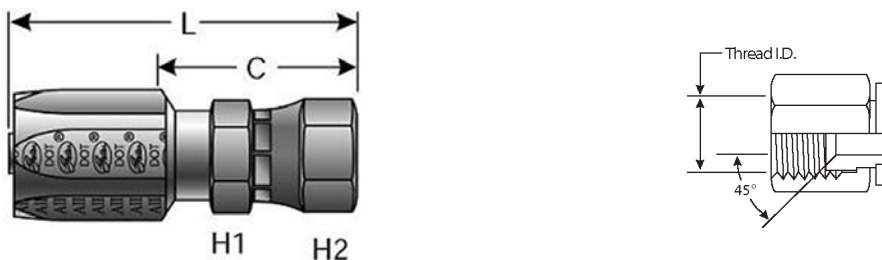

Part No.	Descr.	Prod. No.	⊖		H1	H2	L		C		
			"	mm			"	mm	"	mm	
G35200-0606	6C5E-6RFSX	7238-00955	5/16	7.9	5/8-18	3/4	3/4	2.13	54.1	1.28	32.5
G35200-1212	12C5E-12RFSX	7238-00985	5/8	15.9	1 1/16-14	1 1/4	1 1/4	2.94	74.7	1.80	45.7

### Female SAE 45° Flare Swivel - 45° Bent Tube - Steel

DOT FMVSS Type A1 (No mandrel required).

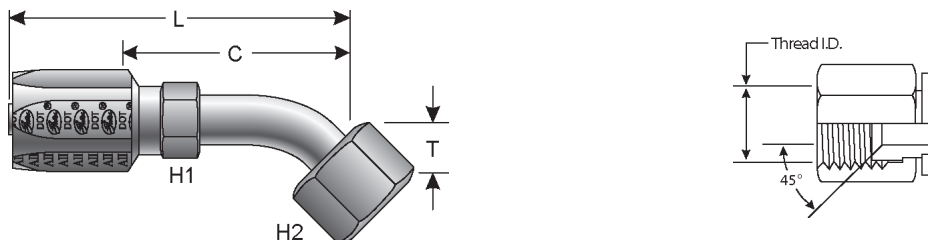

Part No.	Descr.	Prod. No.	⊖		H1	H2	T	L		C			
			"	mm				"	mm	"	mm		
G35202-0606	6C5E-6RFSX45	7235-20425	5/16	7.9	5/8-18	1/2	3/4	.41	10.4	2.33	59.2	1.48	37.6
G35202-1212	12C5E-12RFSX45	7235-20465	5/8	15.9	1 1/16-14	7/8	1 1/4	.78	19.8	3.63	92.2	2.49	63.3



## Female SAE 45° Flare Swivel - 90° Bent Tube - Steel

DOT FMVSS Type A1 (No mandrel required).

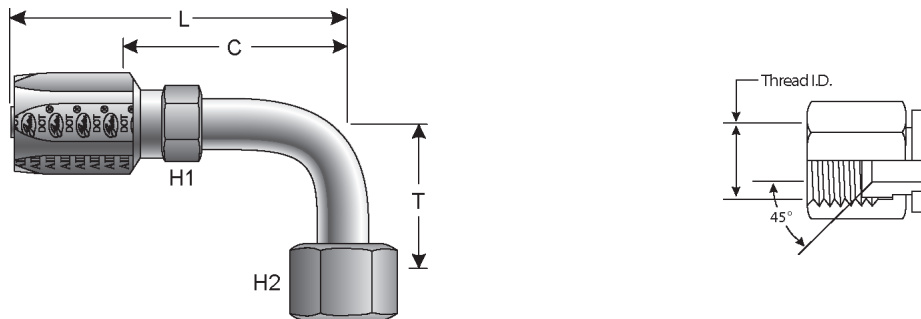

Part No.	Descr.	Prod. No.	⌀		H1	H2	T		L		C		
			"	mm			"	mm	"	mm	"	mm	"
G35205-0606	6C5E-6RFSX90	7235-00315	5/16	7.9	5/8-18	1/2	3/4	.84	21.3	2.21	56.1	1.36	34.5
G35205-1212	12C5E-12RFSX90	7235-00275	5/8	15.9	1 1/16-14	7/8	1 1/4	1.81	46.0	3.58	90.9	2.44	62.0

## Dual Seat Female JIC 37°/SAE 45° Flare Swivel - Steel

DOT FMVSS Type A1 (No mandrel required).

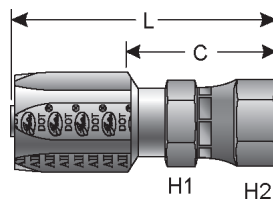

Part No.	Descr.	Prod. No.	⌀		H1	H2	L		C		
			"	mm			"	mm	"	mm	"
G35210-0404	4C5E-4RFJSX	7238-01005	3/16	4.8	7/16-20	1/2	9/16	1.82	46.2	1.10	27.9
G35210-0505	5C5E-5RFJSX	7238-01015	1/4	6.4	1/2-20	1/2	11/16	2.00	50.8	1.21	30.7
G35210-0808	8C5E-8RFJSX	7238-01035	13/32	10.3	3/4-16	7/8	7/8	2.45	62.2	1.45	36.8
G35210-1010	10C5E-10RFJSX	7238-01045	1/2	12.7	7/8-14	1 1/16	1 1/16	2.72	69.1	1.65	41.9

EQUIPMENT
HOSE/CPLG. SELECTION
G8K COUPLINGS
GLOBALSPIRAL COUPLINGS
STAINLESS STEEL SPIRAL
MEGACRIMP COUPLINGS
STAINLESS STEEL BRAID
POWER CRIMP COUPLINGS
FIELD ATTACHABLE G1 & G2 COUPLINGS
FIELD ATTACHABLE C5 COUPLINGS
C14 COUPLINGS
GL COUPLINGS
GLX COUPLINGS
PCTS THERMOPLASTIC COUPLINGS
POLARSEAL COUPLINGS (ACA)
POLARSEAL II COUPLINGS (ACC)
POLARSEAL II COUPLINGS (ACB)
POWER STEERING
ADAPTERS
QUICK DISCONNECT COUPLERS
BALL VALVES
LIVE SWIVEL
ASSEMBLY FABRICATION
ACCESSORIES
EQUIPMENT AND PARTS
KITS
AIR BRAKE HOSE ASSY
BRASS



EQUIPMENT
HOSE/CPLG. SELECTION
G8K COUPLINGS
GLOBAL SPIRAL COUPLINGS
STAINLESS STEEL SPIRAL
MEGACRIMP COUPLINGS
STAINLESS STEEL BRAID
POWER CRIMP COUPLINGS
FIELD ATTACHABLE G1 & G2 COUPLINGS
FIELD ATTACHABLE C5 COUPLINGS
C14 COUPLINGS
GL COUPLINGS
GLX COUPLINGS
PCTS THERMOPLASTIC COUPLINGS
POLARSEAL COUPLINGS (ACA)
POLARSEAL II COUPLINGS (ACC)
POLARSEAL II COUPLINGS (ACB)
POWER STEERING
ADAPTERS
QUICK DISCONNECT COUPLERS
BALL VALVES
LIVE SWIVEL
ASSEMBLY FABRICATION
ACCESSORIES
EQUIPMENT AND PARTS
KITS
AIR BRAKE HOSE ASSY
BRASS

## Dual Seat Female JIC 37°/SAE 45° Flare Swivel - 45° Bent Tube - Steel

DOT FMVSS Type A1 (No mandrel required).

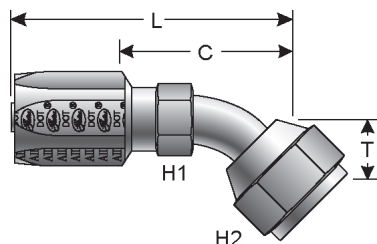

Part No.	Descr.	Prod. No.	⌀		7/16-20	H1	H2	T		L		C	
			"	mm				"	mm	"	mm	"	mm
G35211-0404	4C5E-4RFJSX45	7235-20405	3/16	4.8	7/16-20	1/2	9/16	.34	8.6	1.92	48.8	1.20	30.5
G35211-0808	8C5E-8RFJSX45	7235-20435	13/32	10.3	3/4-16	11/16	7/8	.56	14.2	2.73	69.3	1.73	43.9
G35211-1010	10C5E-10RFJSX45	7235-20445	1/2	12.7	7/8-14	3/4	1	.63	16.0	3.17	80.5	2.11	53.6

## Dual Seat Female JIC 37°/SAE 45° Flare Swivel - 90° Bent Tube - Steel

DOT FMVSS Type A1 (No mandrel required).

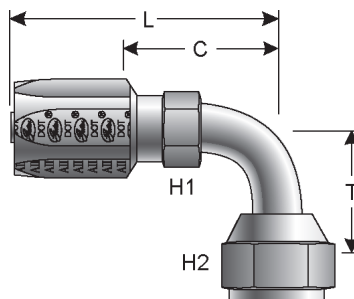

Part No.	Descr.	Prod. No.	⌀		7/16-20	H1	H2	T		L		C	
			"	mm				"	mm	"	mm	"	mm
G35212-0404	4C5E-4RFJSX90	7235-20305	3/16	4.8	7/16-20	1/2	9/16	.69	17.5	1.72	43.7	1.00	25.4
G35212-0808	8C5E-8RFJSX90	7235-20315	13/32	10.3	3/4-16	11/16	7/8	1.09	27.7	2.54	64.5	1.54	39.1
G35212-1010	10C5E-10RFJSX90	7235-20325	1/2	12.7	7/8-14	3/4	1	1.25	31.8	2.97	75.4	1.91	48.5



## Special Flange - 90° - Engine Oil Connection (Code 61 2-Bolt) - Steel

DOT FMVSS Type A1 (No mandrel required).

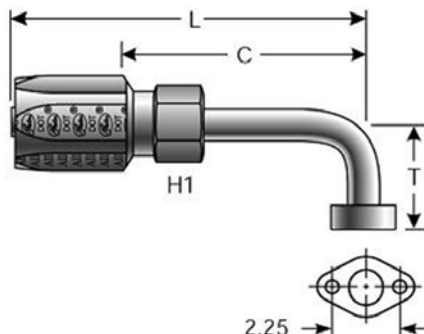

Part No.	Descr.	Prod. No.	⊖		H1	T		L		C	
			"	mm		"	mm	"	mm	"	mm
G35342-2020	20C5E-20RFL90S	7235-20355	1 1/8	28.6	1 9/16	2.50	63.5	4.95	125.7	3.82	97.0

## Male SAE 45° Flare Inverted Swivel - Steel

DOT FMVSS Type A1 (No mandrel required).



Part No.	Descr.	Prod. No.	⊖		H1	H2	L		C		
			"	mm			"	mm	"	mm	
G35500-0404	4C5E-4RMIX	7235-02855	3/16	4.8	7/16-24	1/2	7/16	2.05	52.1	1.33	33.8
G35500-0505	5C5E-5RMIX	7235-02865	1/4	6.4	1/2-20	1/2	1/2	2.26	57.4	1.45	36.8
G35500-0605	6C5E-5RMIX	7235-02875	5/16	7.9	1/2-20	1/2	1/2	2.39	60.7	1.54	39.1
G35500-0606	6C5E-6RMIX	7235-02885	5/16	7.9	5/8-18	1/2	5/8	2.71	68.8	1.86	47.2
G35500-0808	8C5E-8RMIX	7235-02895	13/32	10.3	3/4-18	11/16	3/4	3.24	82.3	2.24	56.9

- EQUIPMENT
- HOSE/CPLG. SELECTION
- G8K COUPLINGS
- GLOBALSPIRAL COUPLINGS
- STAINLESS STEEL SPIRAL
- MEGACRIMP COUPLINGS
- STAINLESS STEEL BRAID
- POWER CRIMP COUPLINGS
- FIELD ATTACHABLE G1 & G2 COUPLINGS
- FIELD ATTACHABLE C5 COUPLINGS
- C14 COUPLINGS
- GL COUPLINGS
- GLX COUPLINGS
- PCTS THERMOPLASTIC COUPLINGS
- POLARSEAL COUPLINGS (ACA)
- POLARSEAL II COUPLINGS (ACC)
- POLARSEAL II COUPLINGS (ACB)
- POWER STEERING
- ADAPTERS
- QUICK DISCONNECT COUPLERS
- BALL VALVES
- LIVE SWIVEL
- ASSEMBLY FABRICATION
- ACCESSORIES
- EQUIPMENT AND PARTS
- KITS
- AIR BRAKE HOSE ASSY
- BRASS



EQUIPMENT
HOSE/CPLG. SELECTION
G8K COUPLINGS
GLOBALSPIRAL COUPLINGS
STAINLESS STEEL SPIRAL
MEGACRIMP COUPLINGS
STAINLESS STEEL BRAID
POWER CRIMP COUPLINGS
FIELD ATTACHABLE G1 & G2 COUPLINGS
FIELD ATTACHABLE C5 COUPLINGS
C14 COUPLINGS
GL COUPLINGS
GLX COUPLINGS
PCTS THERMOPLASTIC COUPLINGS
POLARSEAL COUPLINGS (ACA)
POLARSEAL II COUPLINGS (ACC)
POLARSEAL II COUPLINGS (ACB)
POWER STEERING
ADAPTERS
QUICK DISCONNECT COUPLERS
BALL VALVES
LIVE SWIVEL
ASSEMBLY FABRICATION
ACCESSORIES
EQUIPMENT AND PARTS
KITS
AIR BRAKE HOSE ASSY
BRASS

## Male SAE 45° Flare Inverted Swivel - 45° Bent Tube - Steel

DOT FMVSS Type A1 (No mandrel required).

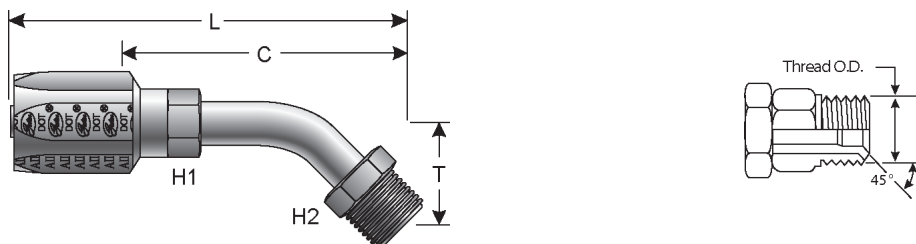

Part No.	Descr.	Prod. No.	⌀		H1	H2	T		L		C		
			"	mm			"	mm	"	mm	"	mm	
G35502-0606	6C5E-6RMIX45	7235-02795	5/16	7.9	5/8-18	1/2	5/8	.84	21.3	3.79	96.3	2.94	74.7
G35502-0808	8C5E-8RMIX45	7235-02905	13/32	10.3	3/4-18	11/16	3/4	1.09	27.7	4.24	107.7	3.24	82.3

## Male SAE 45° Flare Inverted Swivel - 90° Bent Tube - Steel

DOT FMVSS Type A1 (No mandrel required).

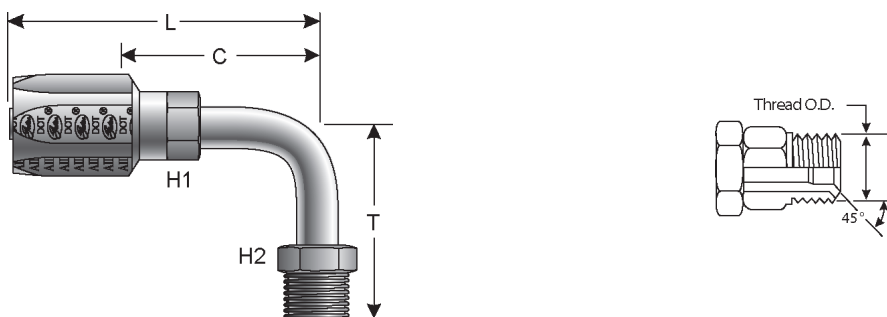

Part No.	Descr.	Prod. No.	⌀		H1	H2	T		L		C		
			"	mm			"	mm	"	mm	"	mm	
G35504-0404	4C5E-4RMIX90	7235-02805	3/16	4.8	7/16-24	1/2	7/16	1.25	31.8	2.05	52.1	1.33	33.8
G35504-0505	5C5E-5RMIX90	7235-02815	1/4	6.4	1/2-20	1/2	1/2	1.50	38.1	2.25	57.2	1.46	37.1
G35504-0605	6C5E-5RMIX90	7235-02825	5/16	7.9	1/2-20	1/2	1/2	1.50	38.1	2.39	60.7	1.54	39.1
G35504-0606	6C5E-6RMIX90	7235-02835	5/16	7.9	5/8-18	1/2	5/8	1.63	41.4	2.71	68.8	1.86	47.2
G35504-0808	8C5E-8RMIX90	7235-02845	13/32	10.3	3/4-18	11/16	3/4	2.00	50.8	3.24	82.3	2.24	56.9



### SAE Male Flareless Assembly - Steel

DOT FMVSS Type A1 (No mandrel required).

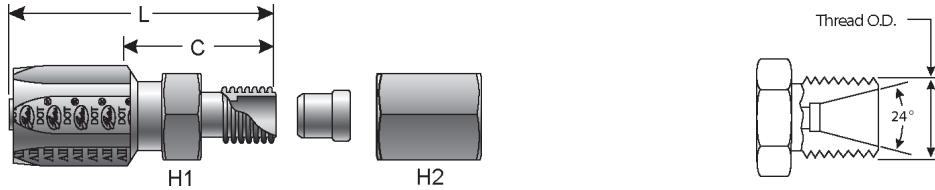

Part No.	Descr.	Prod. No.	⊖		🌀	H1	H2	L		C	
			"	mm				"	mm	"	mm
G35510-0404	4C5E-4RMFA	7236-04955	3/16	4.8	7/16-20	1/2	9/16	1.68	42.7	.96	24.4
G35510-0505	5C5E-5RMFA	7236-04965	1/4	6.4	1/2-20	9/16	5/8	1.72	43.7	.92	23.4
G35510-0604	6C5E-4RMFA	7236-04975	5/16	7.9	7/16-20	9/16	9/16	2.12	53.9	1.01	25.7
G35510-0606	6C5E-6RMFA	7236-04985	5/16	7.9	9/16-18	5/8	11/16	1.87	47.5	1.03	26.2
G35510-0808	8C5E-8RMFA	7236-04995	13/32	10.3	3/4-16	13/16	7/8	2.15	54.6	1.15	29.2
G35510-1010	10C5E-10RMFA	7236-05005	1/2	12.7	7/8-14	15/16	1	2.34	59.4	1.27	32.3

### Parker Triple Thread Female Swivel - Steel

DOT FMVSS Type A1 (No mandrel required).



Part No.	Descr.	Prod. No.	⊖		🌀	H1	H2	L		C	
			"	mm				"	mm	"	mm
G35562-1616	16C5E-16RFZX	7238-01075	7/8	22.2	1 5/16-14	1 1/2	1 1/2	2.74	69.6	1.68	42.7

- EQUIPMENT
- HOSE/CPLG. SELECTION
- G8K COUPLINGS
- GLOBALSPIRAL COUPLINGS
- STAINLESS STEEL SPIRAL
- MEGACRIMP COUPLINGS
- STAINLESS STEEL BRAID
- POWER CRIMP COUPLINGS
- FIELD ATTACHABLE G1 & G2 COUPLINGS
- FIELD ATTACHABLE C5 COUPLINGS
- C14 COUPLINGS
- GL COUPLINGS
- GLX COUPLINGS
- PCTS THERMOPLASTIC COUPLINGS
- POLARSEAL COUPLINGS (ACA)
- POLARSEAL II COUPLINGS (ACC)
- POLARSEAL II COUPLINGS (ACB)
- POWER STEERING
- ADAPTERS
- QUICK DISCONNECT COUPLERS
- BALL VALVES
- LIVE SWIVEL
- ASSEMBLY FABRICATION
- ACCESSORIES
- EQUIPMENT AND PARTS
- KITS
- AIR BRAKE HOSE ASSY
- BRASS